



Description of the Measurement • 12/2014

Help and Explanations of the Measurement – "Data Transfer via Industrial Ethernet"

KommIE ID30

Warranty and liability

Note

The Application Examples are not binding and do not claim to be complete regarding the circuits shown, equipping and any eventuality. The Application Examples do not represent customer-specific solutions. They are only intended to provide support for typical applications. You are responsible for ensuring that the described products are used correctly. These application examples do not relieve you of the responsibility to use safe practices in application, installation, operation and maintenance. When using these Application Examples, you recognize that we cannot be made liable for any damage/claims beyond the liability clause described. We reserve the right to make changes to these Application Examples at any time without prior notice.

If there are any deviations between the recommendations provided in these application examples and other Siemens publications – e.g. Catalogs – the contents of the other documents have priority.

We do not accept any liability for the information contained in this document.

Any claims against us – based on whatever legal reason – resulting from the use of the examples, information, programs, engineering and performance data etc., described in this Application Example shall be excluded. Such an exclusion shall not apply in the case of mandatory liability, e.g. under the German Product Liability Act (“Produkthaftungsgesetz”), in case of intent, gross negligence, or injury of life, body or health, guarantee for the quality of a product, fraudulent concealment of a deficiency or breach of a condition which goes to the root of the contract (“wesentliche Vertragspflichten”). The damages for a breach of a substantial contractual obligation are, however, limited to the foreseeable damage, typical for the type of contract, except in the event of intent or gross negligence or injury to life, body or health. The above provisions do not imply a change of the burden of proof to your detriment.

Any form of duplication or distribution of these Application Examples or excerpts hereof is prohibited without the expressed consent of the Siemens AG.

Security information

Siemens provides products and solutions with industrial security functions that support the secure operation of plants, solutions, machines, equipment and/or networks. They are important components in a holistic industrial security concept. With this in mind, Siemens' products and solutions undergo continuous development. Siemens recommends strongly that you regularly check for product updates.

For the secure operation of Siemens products and solutions, it is necessary to take suitable preventive action (e.g. cell protection concept) and integrate each component into a holistic, state-of-the-art industrial security concept. Third-party products that may be in use should also be considered. For more information about industrial security, visit <http://www.siemens.com/industrialsecurity>.

To stay informed about product updates as they occur, sign up for a product-specific newsletter. For more information, visit <http://support.automation.siemens.com>.

Table of Contents

	Warranty and liability.....	2
1	Operating the User Interface	4
1.1	Overview of the user interface	4
1.2	How to operate the user interface	6
1.2.1	Initial situation when starting the application	6
1.2.2	Entering the desired configuration	8
1.2.3	Entering the performance requirements.....	10
1.2.4	View of the selected configuration	11
1.2.5	Performance data table	11
2	Scope of the Measurement.....	14
2.1	Objective.....	14
2.2	Performance data provided	14
2.3	Parameters of the measurement.....	15
2.4	Scope of validity and technical data	16
3	Performing the Measurement.....	18
3.1	Measurement setup and method of measurement	18
3.2	Measurement setup.....	19
3.3	Measurement: Transfer time	20
3.4	Measurement: Cycle time.....	21
3.5	Measurement: PN IO update time.....	22
3.6	Measured variables and statistics	22
3.7	Explanatory notes on the STEP 7 program.....	25
3.7.1	Overview of the STEP 7 programs.....	25
3.7.2	Communication program	27
3.7.3	Load program	27
4	Version.....	28

1 Operating the User Interface

The following chapters provide you with information on how to operate the measurement via the path user interface.

1.1 Overview of the user interface

The user interface is divided into four areas: Selection area, Performance Requirements, Chosen topology and performance data table. All areas, except the performance data table, can be collapsed and expanded.

Selection area

Figure 1-1

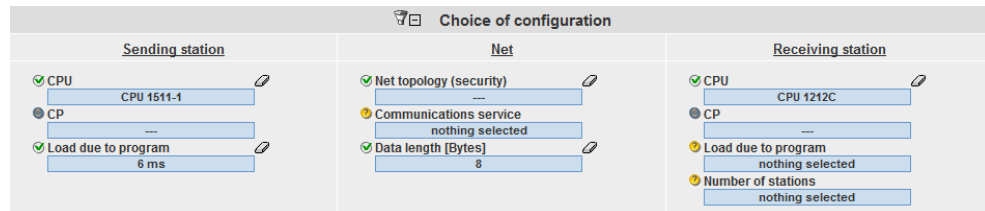

In this area, you can enter your desired configuration using the appropriate operator controls. The system supports you through various automatic functions.

Table 1-1

Icon	Explanation
	The parameter has not yet been set.
	The parameter available for selection was set by you.
	The parameter was automatically set by the system. The range of values had to be restricted due to the selection of another control (internal rules).
	Clicking the eraser icon resets the selection.
	The "filter icon" indicates that at least one filter is active in the selection area.
	+ Expand input area - Collapse input area

Performance Requirements

Figure 1-2

In this area, numerical filter conditions that appear when clicking the appropriate control allow you to additionally restrict the measured values of the results table.

In this example, the minimum transmission delay time is to be less than 15 ms. In addition to the filters of the selection area, this filter will now be used for the results table.

Chosen topology

Figure 1-3

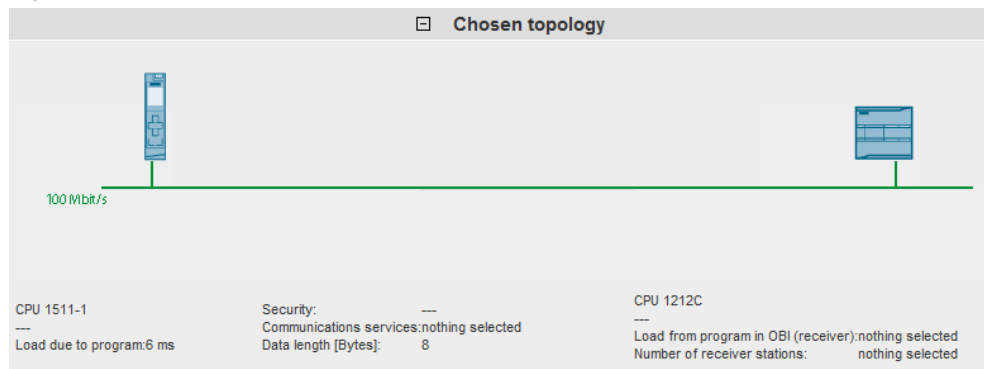

In the "Chosen topology" area, the system displays the graphical structure of your configuration. If nothing has been entered for one or more controls in the selection area, this is indicated by a question mark  or a '---' in the specific area.

Performance data table

Figure 1-4

Protocol	TransTime_avg[ms]
PWD	8,4
OUC (UDP)	13,7
OUC (TCP)	14,6

This area displays the measured performance data with all the filters you have selected. More columns can be shown or hidden using a dialog box by clicking "Show columns". Clicking "Download results (*.csv)" allows you to export the displayed selection as an Excel csv spreadsheet. This allows you to make more individual sorts for your applications.

1.2 How to operate the user interface

The following chapters provide you with information on how to operate the user interface.

1.2.1 Initial situation when starting the application

When calling the web application for the first time, the status of the application is as follows:

User interface

Figure 1-5

The screenshot shows a web application interface with a top navigation bar containing 'Performance data for the communication via IE', 'Language', 'Contact', and 'help'. Below this is a 'Choice of configuration' section with three columns: 'Sending station', 'Net', and 'Receiving station'. Each column contains several options with 'nothing selected' buttons. Below this is a 'Performance Requirements' section (hidden) and a 'Chosen topology' section (hidden). At the bottom is a table with 11 columns: S-CPU, S-Prg-Load, S-CP, Protocol, DataLength, R-CPU, R-Prg-Load, R-CP, Num Stations, and TransTime_avg[ms]. The table contains 2696 rows of data. A 'Download results (*.csv)' button and a 'Show columns' link are also visible.

S-CPU	S-Prg-Load	S-CP	Protocol	DataLength	R-CPU	R-Prg-Load	R-CP	Num Stations	TransTime_avg[ms]
CPU 1511-1	0 ms	---	OUC (TCP)	1024	CPU 1511-1	0 ms	---	1	0,1
CPU 1516-3	0 ms	---	OUC (TCP)	1024	CPU 1511-1	0 ms	---	1	0,1
CPU 1516-3	0 ms	---	OUC (ISOonTCP)	1024	CPU 1511-1	0 ms	---	1	0,1
CPU 1511-1	0 ms	---	OUC (ISOonTCP)	1024	CPU 1511-1	0 ms	---	1	0,6
CPU 1215C	0 ms	---	PNIO	200	CPU 315-2PN/DP	0 ms	---	1	1,2
CPU 1516-3	0 ms	CP1543-1	OUC (TCP)	1024	CPU 1511-1	0 ms	CP1543-1	1	1,5
CPU 1516-3	0 ms	CP1543-1	OUC (ISOonTCP)	1024	CPU 1511-1	0 ms	CP1543-1	1	1,7
CPU 1511-1	0 ms	CP1543-1	OUC (TCP)	1024	CPU 1511-1	0 ms	CP1543-1	1	1,8
CPU 1511-1	0 ms	---	PNIO	200	CPU 315-2PN/DP	0 ms	---	8	1,9
CPU 1511-1	0 ms	---	PNIO	8	CPU 315-2PN/DP	0 ms	---	8	2
CPU 1516-3	0 ms	---	PNIO	200	CPU 315-2PN/DP	0 ms	---	8	2
CPU 1516-3	0 ms	---	PNIO	8	CPU 315-2PN/DP	0 ms	---	8	2
CPU 1511-1	0 ms	---	OUC (ISOonTCP)	1024	CPU 315-2PN/DP	0 ms	---	1	2,1
CPU 1516-3	0 ms	---	PNIO	8	CPU 1511-1	0 ms	---	8	2,3
CPU 1511-1	0 ms	CP1543-1	OUC (ISOonTCP)	1024	CPU 1511-1	0 ms	CP1543-1	1	2,3
CPU 1516-3	0 ms	---	PNIO	200	CPU 1511-1	0 ms	---	8	2,6
CPU 1516-3	0 ms	---	OUC (TCP)	1024	CPU 315-2PN/DP	0 ms	---	1	2,7
CPU 1516-3	0 ms	---	OUC (ISOonTCP)	1024	CPU 315-2PN/DP	0 ms	---	1	2,7
CPU 1511-1	0 ms	---	OUC (TCP)	1024	CPU 315-2PN/DP	0 ms	---	1	2,8
CPU 1511-1	0 ms	---	PNIO	8	CPU 1212C	0 ms	---	8	3,3

The "Choice of configuration" area and the performance data table are always visible. The "Performance Requirements" and "Chosen topology" areas are hidden.

Description of the menu items

The following section explains the items of the application menu bar.

Figure 1-6

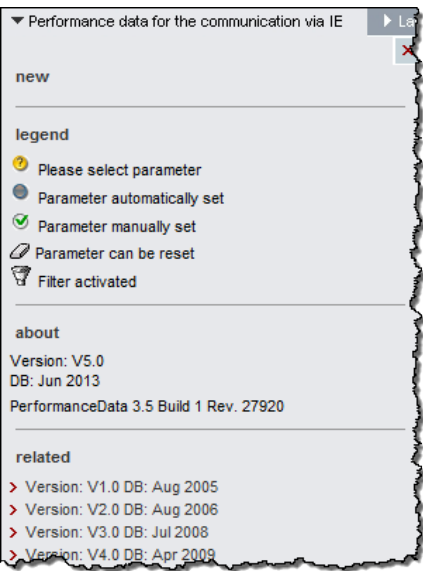

Menu item	Description
	<p>Clicking the Performance data for communication via IE menu item opens a dialog where</p> <ul style="list-style-type: none"> • clicking the new menu item restores the user interface to its initial state. • the legend area provides you with an explanation of the most important icons. • the about area displays the version number of the measurement and the database. • the related area allows you to directly switch to other versions of this measurement type.
Language	The user interface is implemented in German and English.
Contact	Links to the Online Support
help	Allows you to call these help pages

1.2.2 Entering the desired configuration

In the "Choice of configuration" area, you can specify the desired hardware configuration.

Table 1-2

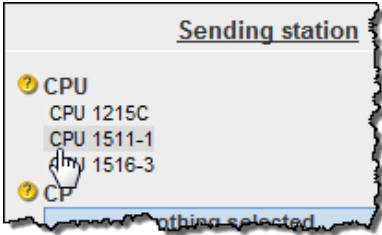
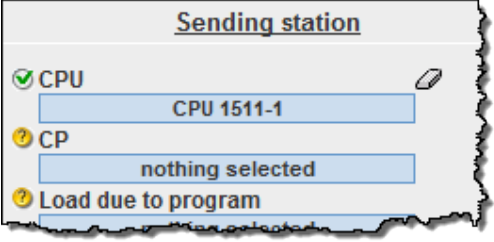
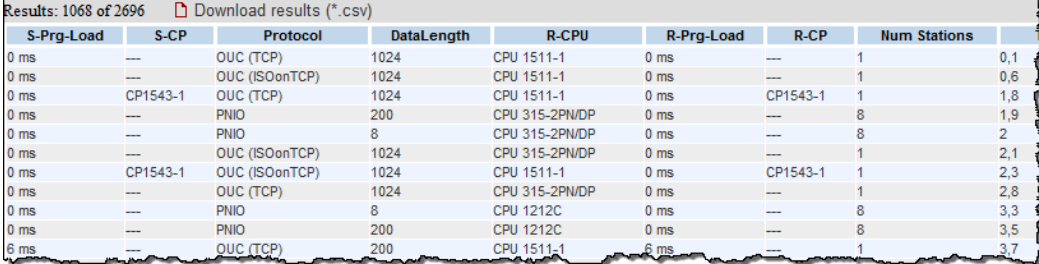
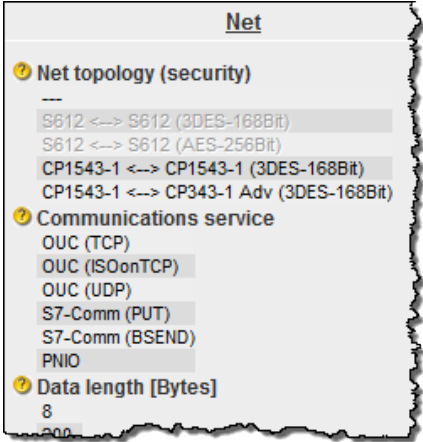
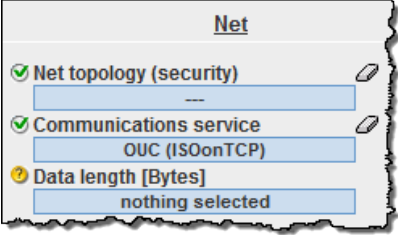
No.	Operator action	System response
1.	<p>Select a configuration by clicking the various parameter controls and selecting a component. Example: Selection of a CPU in the <u>Sending station</u> area</p> 	<p>The system has applied your desired CPU (here: CPU 1511-1 PN) and at the same time, where applicable, automatically made the following selection of the CP for you.</p> 
<p>The system has immediately sent a query with the currently active filter to the database and displayed it in the performance data table.</p>  <p>In this example, 1068 out of a total of 2696 measured values are available with this exact CPU. As the send CPU has now been permanently assigned, this column has been removed from the results table.</p>		
2.	<p>Proceed in the same way to enter the parameters of your choice for the "Net" and "Services" area. Example: Selection of the OUC protocol (ISOonTCP) and no security</p> 	<p>The system has applied your desired entries.</p> 

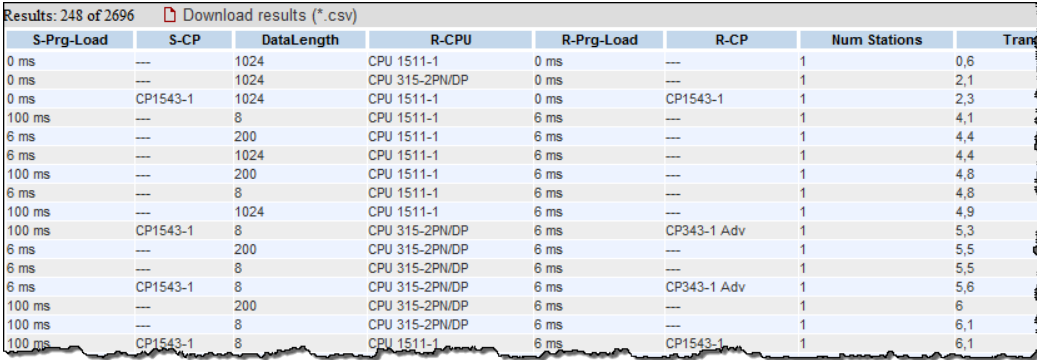
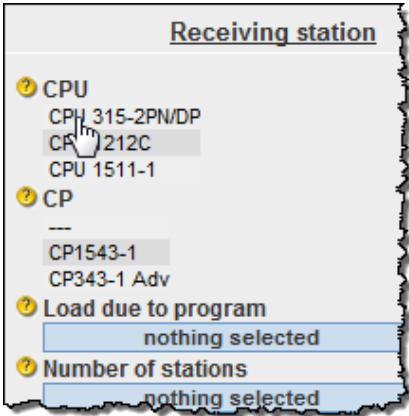
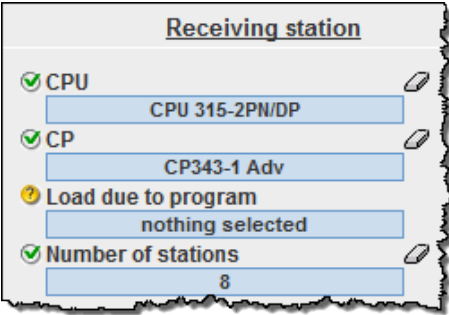
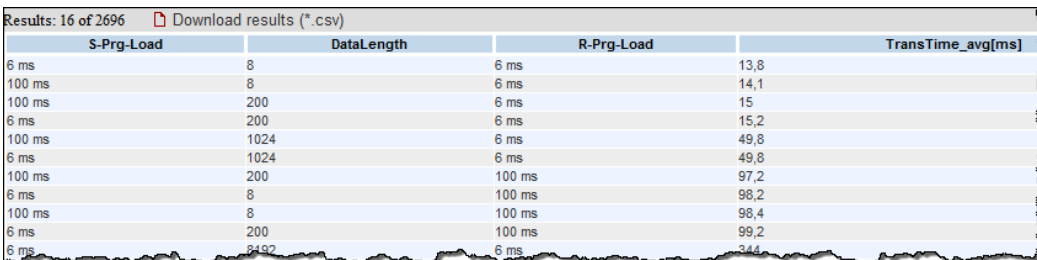
No.	Operator action	System response
	<p>As in 1, the system has performed another database query with the advanced filter settings and therefore further restricted the number of relevant measured values.</p> 	
<p>3.</p>	<p>Proceed in the same way to enter the parameters of your choice for the "Receiving station" area.</p> <p>Example: Successive selection of CPU type CPU 315-2PN/DP with CP 343-1 adv. with a total of 8 stations.</p> 	<p>The system has applied your entries.</p> 
	<p>Once again, the system has performed a database query with the advanced filter settings and removed the now defined columns from the results table.</p> 	

1.2.3 Entering the performance requirements

In addition to specifying the hardware components, you can restrict the range of tolerable transmission delay times in the "Performance Requirements" filter area.

Table 1-3

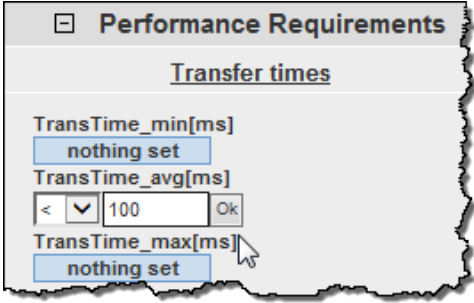
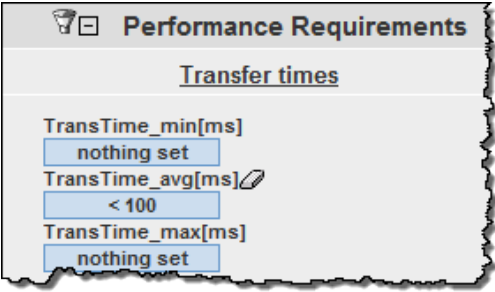
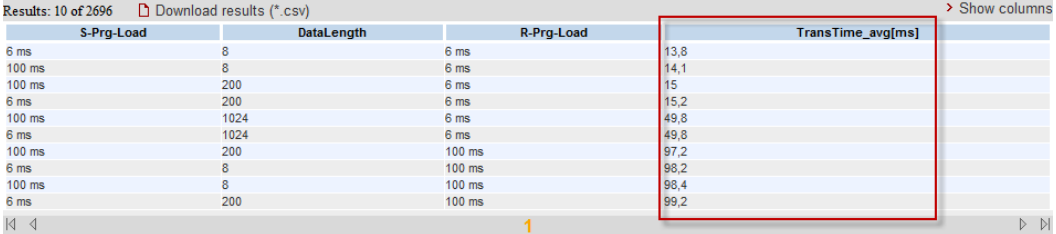
No.	Operator action	System response
1.	<p>Enter the minimum, average or maximum values required in your plant. For a description of the different measured values, please refer to Chapter 2.2; a tooltip directly on the control provides a brief explanation.</p> <p><u>Example:</u> The maximum tolerable average transmission delay time of your application is to be 100 ms.</p>  <p>Confirm your entry by clicking the OK button.</p>	<p>The system has applied your desired entry.</p> 
		<p>The system has sent a query with the now active filters to the database and displayed it in the performance data table.</p>  <p>With the selected sample filter settings, the system has found 10 data records remaining that meet all default criteria.</p>

1.2.4 View of the selected configuration

Expanding the "Chosen topology" area allows you to view the hardware configuration diagram for this topology.

Figure 1-7

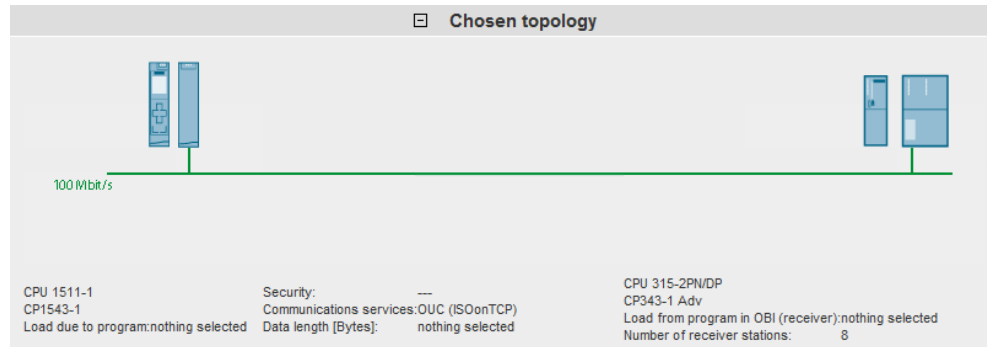

Components that have not been selected are indicated by a question mark icon



in the graphic and "nothing selected" or "---" in the text.

1.2.5 Performance data table

The performance data table shows the database contents of the respective measurement restricted by the previous filters. This area is permanently visible. By default, the table displays only a selection of the columns available in the database for this measurement. A dialog box allows you to select or deselect individual columns.

Control elements of the table

Figure 1-8

Results: 1327 of 2696 Download results (*.csv) Show columns

S-CPU	S-Prg-Load	S-CP	Protocol	DataLength	R-CPU	R-Prg-Load	R-CP	Num Stations	TransTime_avg(ms)
CPU 1516-3	100 ms	CP1543-1	S7-Comm (BSEND)	8192	CPU 315-2PN/DP	100 ms	CP343-1 Adv	16	2165,5
CPU 1516-3	6 ms	CP1543-1	S7-Comm (BSEND)	8192	CPU 315-2PN/DP	100 ms	CP343-1 Adv	16	1,8
CPU 1516-3	100 ms	CP1543-1	S7-Comm (BSEND)	8192	CPU 315-2PN/DP	100 ms	CP343-1 Adv	16	2,4
CPU 1516-3	6 ms	CP1543-1	S7-Comm (BSEND)	8192	CPU 315-2PN/DP	100 ms	CP343-1 Adv	16	7000,7
CPU 1516-3	100 ms	CP1543-1	S7-Comm (BSEND)	8192	CPU 315-2PN/DP	100 ms	CP343-1 Adv	8	6116,2
CPU 1516-3	6 ms	CP1543-1	S7-Comm (BSEND)	8192	CPU 315-2PN/DP	100 ms	CP343-1 Adv	8	5906,2
CPU 1516-3	100 ms	CP1543-1	S7-Comm (BSEND)	8192	CPU 315-2PN/DP	100 ms	CP343-1 Adv	1	4640
CPU 1516-3	100 ms	CP1543-1	S7-Comm (BSEND)	8192	CPU 315-2PN/DP	100 ms	CP343-1 Adv	1	4634,6
CPU 1516-3	6 ms	CP1543-1	S7-Comm (BSEND)	8192	CPU 315-2PN/DP	100 ms	CP343-1 Adv	1	4545,7
CPU 1516-3	6 ms	CP1543-1	S7-Comm (BSEND)	8192	CPU 315-2PN/DP	100 ms	CP343-1 Adv	1	4513,6
CPU 1516-3	6 ms	CP1543-1	OUC (TCP)	8192	CPU 315-2PN/DP	100 ms	CP343-1 Adv	16	3651,5
CPU 1516-3	100 ms	CP1543-1	OUC (TCP)	8192	CPU 315-2PN/DP	100 ms	CP343-1 Adv	16	3648,9
CPU 1516-3	6 ms	CP1543-1	S7-Comm (BSEND)	8192	CPU 315-2PN/DP	6 ms	CP343-1 Adv	16	2672,6
CPU 1516-3	100 ms	CP1543-1	S7-Comm (BSEND)	8192	CPU 315-2PN/DP	6 ms	CP343-1 Adv	16	2652,5
CPU 1516-3	100 ms	CP1543-1	S7-Comm (BSEND)	8192	CPU 315-2PN/DP	6 ms	CP343-1 Adv	16	2517,9
CPU 1516-3	6 ms	CP1543-1	S7-Comm (BSEND)	8192	CPU 315-2PN/DP	6 ms	CP343-1 Adv	16	2310,3
CPU 1516-3	6 ms	CP1543-1	S7-Comm (BSEND)	1024	CPU 315-2PN/DP	100 ms	CP343-1 Adv	16	2281,4
CPU 1516-3	6 ms	CP1543-1	S7-Comm (BSEND)	1024	CPU 315-2PN/DP	100 ms	CP343-1 Adv	16	2246,9
CPU 1516-3	6 ms	CP1543-1	OUC (ISOonTCP)	8192	CPU 315-2PN/DP	100 ms	CP343-1 Adv	16	1822
CPU 1516-3	100 ms	CP1543-1	S7-Comm (BSEND)	1024	CPU 315-2PN/DP	100 ms	CP343-1 Adv	16	1750,6

Navigation: 1 | 2 | 3 | 4 | 5 | 6 | 3

Explanation of the control elements

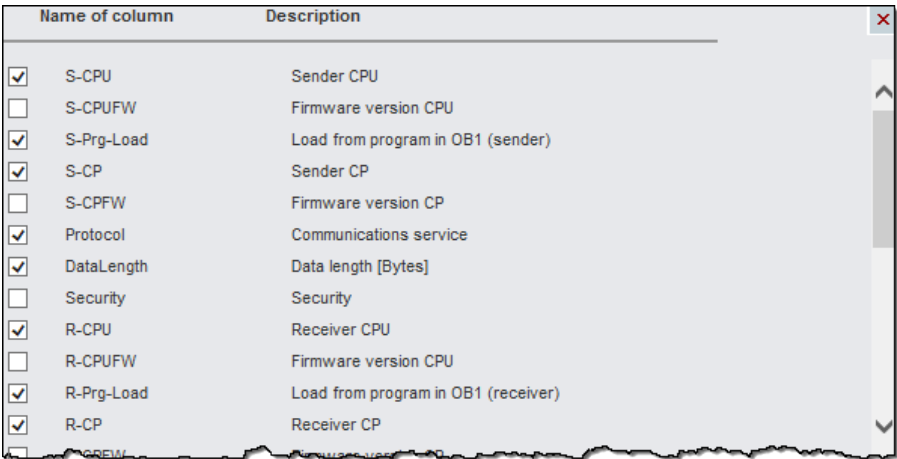
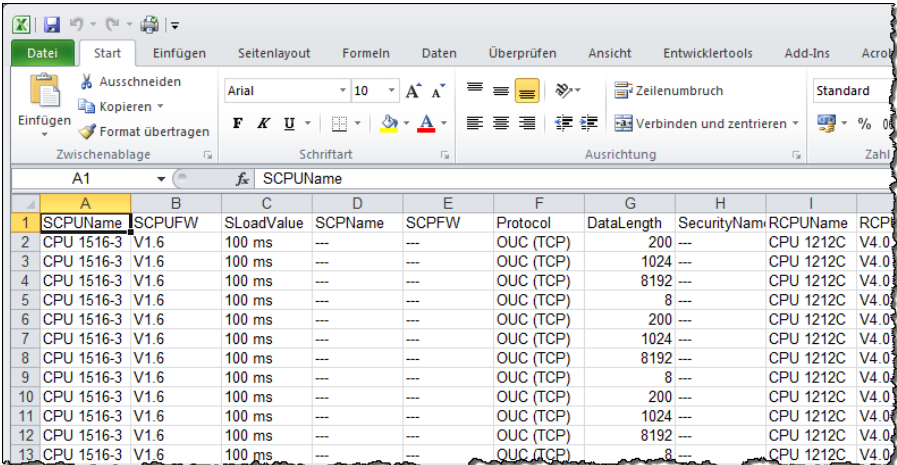
No.	Explanation
1	<p>The following table describes the control elements of figure 1-8</p> <ul style="list-style-type: none"> • the number of results • the maximum number of data records of this measurement.
2	<p>Clicking the "> Show columns" control element opens a dialog box where you can select or deselect individual columns.</p> 
3	<p>Provided that there are multiple results pages, the control bar elements of the table control allow you to select the individual results pages and go to the next, previous, last or first page.</p>
4	<p>When you click "Download results (*.csv)", the web server uploads all contents of the results table to the client browser as a csv file. Depending on the installed software, the data is immediately displayed in an Excel spreadsheet.</p> 
5	<p>Clicking the column header of the measured values (in this example - TransTime_avg) triggers a sorting of the table according to this criterion. Clicking a column header changes the sort state of the appropriate column.</p> <p> <input type="checkbox"/> T Rea min [ms] Values unsorted <input checked="" type="checkbox"/> T Rea min [ms] Values sorted in ascending order <input checked="" type="checkbox"/> T Rea min [ms] Values sorted in descending order </p> <p>Note: You can only sort one column at a time!</p>

Meaning of the columns

Tooltips provide more detailed explanations of all column headers.

Table 1-4

Column name	Explanation
S-CPU	Sender CPU type
S-CPUFW	CPU firmware version (sender)
S-Prg-Load	Load due to program in OB1 (sender CPU)
S-CP	Sender CP
S-CPFWS	CP firmware version (sender)
Protocol	Communications service
DataLength	Net data length of message [bytes]
Security	Security through VPN
R-CPU ⁽²⁾	Receiver CPU type
R-CPUFW	CPU firmware version (receiver)
R-Prg-Load ⁽²⁾	Load due to program in OB1 (receiver CPU)
R-CP ⁽²⁾	Receiver CP
R-CPFWS	CP firmware version (receiver)
Num Stations ⁽²⁾	Number of receiver stations
TransTime_min[ms]	Minimum transmission time [ms]
TransTime_Q25[ms]	25% quartile of transmission time [ms]
TransTime_avg[ms]	Median of transmission time [ms]
TransTime_Q75[ms]	75% quartile of transmission time [ms]
TransTime_max[ms]	Maximum transmission time [ms]
Outlier[%]	Number of outliers of all measured values in %
S-Cycle time min[ms]	Minimum OB1 sender cycle time [ms]
S-Cycle time avg[ms]	Average OB1 sender cycle time [ms]
S-Cycle time max[ms]	Maximum OB1 sender cycle time [ms]
R-Cycle time min[ms]	Minimum OB1 receiver cycle time [ms]
R-Cycle time avg[ms]	Average OB1 receiver cycle time [ms]
R-Cycle time max[ms]	Maximum OB1 receiver cycle time [ms]
PNIO_SendClock[ms]	PN IO send clock [ms]

2 Scope of the Measurement

2.1 Objective

Automation projects often require intensive data exchange between SIMATIC S7 controllers. The possible communication paths vary considerably. Numerous S7 controllers and S7 communication modules are available.

To be able to make the right choice in the concept phase of an automation project, it is important to know the communication performance of a planned configuration.

Important questions

- Which S7 components are best suited for the planned automation project?
- Which data transfer times can be expected for typical configurations?
- Which statistical fluctuations can occur?
- How does the data communication affect the cycle time (OB1) of the sending and receiving S7 controller?

Scope of these measurements

In order to answer these questions, we have performed extensive measurements under conditions relevant to practical operation:

- With typical S7 components
- With typical parameters and configurations
- With a load program relevant to practical operation in the S7 controller

To conveniently access the measurement results, you can compose your desired configuration using the interactive user interface.

2.2 Performance data provided

The following performance data or measured variables are available to you:

Table 2-1

Measured variable	Definition
Transfer time	<p>At a defined time, the sending station transfers data once to all configured receiving stations.</p> <p>The time between event 1 and event 2 is measured.</p> <ul style="list-style-type: none"> • Event 1: Simultaneous trigger of all send jobs in OB1 of the sending S7 controller. • Event 2: All the data is completely in the user area of all receiving S7 controllers.
Cycle time in sender	<p>This is the interval between two process image updates in the sender CPUs.</p>

Measured variable	Definition
Cycle time in receiver	This is the interval between two process image updates in the receiver CPUs.
PN update time	The PN update time is the time that, in the case of data communication via PROFINET IO, passes between two IO cycles of the IO controller. This time is calculated by STEP 7 and not measured.

Note For a detailed description of the method of measurement, please refer to Chapter 3 Operating the User Interface.

2.3 Parameters of the measurement

This measurement was performed with the following parameters:

Table 2-2

Component	Parameter	Explanation
Sending station	CPU	Selection of the CPU type.
	CP	Setting of the CP type. Communication path via the integrated interface of the CPU or use of a CP.
	Load due to program	Setting of the program load implemented in the sending station by an additional STEP 7 program.
Net	Net topology (security)	Setting of the paths relevant to security (via VPN tunnel(s)).
	Communications service	Setting of the transmission protocol.
	Data length	Setting of the net data volume.
Receiving station	CPU	Setting of the CPU type.
	Load due to program	Setting of the load implemented in the receiving station by an additional STEP 7 program.
	CP	Setting of the CP type. Communication path via the integrated interface of the CPU or use of a CP.
	Number of stations	Setting of the number of receiving stations.

Note The ranges of values of the individual parameters that can be set may vary depending on the configuration. This is indicated by the respective displays in the user interface.

2.4 Scope of validity and technical data

Scope of validity

The measurement covers a typical range of components. The selection follows the most current and most frequently used products as at "June 2013".

The measured values apply provided that the network has been configured correctly. Due to system-internal error control, an incorrect or incomplete configuration causes significantly deviating times.

Boundary conditions of the measurement

All measured values were acquired under specific boundary conditions (configuration and parameterization).

All settings essential to the measurement can be found in the following table. STEP 7 default values are used for all settings that are not listed.

Table 2-3

Constant	Range of values	Comment
Cycle load due to communication	S7-1200/1500: 50% S7-300 : 20%	
Prioritized operator interface services for S7-300 receiving stations	on	This has effects on the S7 communication variant with PUT/GET.
VPN	Mode	The SCALANCE S/CP1543-1/CP343-1 GX31 are only configured in bridge mode.
	Authentication method via certificate with <ul style="list-style-type: none"> • 3DES 168-bit key • AES 256-bit key) 	For CPs, only the 3DES method is possible
Addressing	Symbolic	The default setting for generating the data blocks for TIAP V12/13 is "Optimized block access".

Components used

The following table contains all components that were used in this measurement.

Table 2-4

Component		Type	Article no.	Version
Sending station	S7-1200	CPU 1215C	6ES7215-1AG40-0XB0	V4.0
	S7-1500	CPU 1511-1PN	6ES7511-1AK00-0AB0	V1.1
		CPU 1516-3PN/DP	6ES7516-3AN00-0AB0	V1.6
		CP 1543-1	6GK7543-1AX00-0XE0	V1.1
Net	Security components	SCALANCE S612	6GK5612-0BA10-2AA3	V4.0
Receiving stations	S7-1200	CPU 1212C	6ES7212-1AE40-0XB0	V4.0
	S7-1500	CPU 1511-1	6ES7511-1AK00-0AB0	V1.1
		CP 1543-1	6GK7543-1AX00-0XE0	V1.1
	S7-300	CPU 315-2PN/DP	6ES7315-2EH14-0AB0	V3.2
		CP 343-1 Adv	6GK7343-1GX31-0XE0	V3.0
Engineering		STEP 7 (TIA Portal)		V12 SP1 V13
		SCT		

3 Performing the Measurement

The following chapters provide information on how to perform the measurements.

3.1 Measurement setup and method of measurement

Measuring sequence

The basic sequence of a measurement is as follows:

1. Configuring a configuration, including the download to all stations involved.
2. Measuring all measured variables (each measurement is repeated several times).
3. Evaluating the measurements and determining the statistical position parameters.

Method of measurement for the performance data

- **Transfer time**
The transfer time indicates how long it takes to send a data packet from the user area (data block) of the sending station to the user area (data block) of all receiving stations. Approx. 200 – 500 single measurements are performed for a measurement.
- **Cycle time**
In the send CPU and in a receive CPU, the cycle time is measured via the start information of OB1 (S7-300), determined via a separate measuring program (S7-1200) or the available system functions (S7-1500). The cycle time (approx. 200 to 500 cycles) is acquired when communication is active.
- **PN IO update time**
When PN IO is selected as the transmission protocol, the data is transferred to the iDevice via the PROFINET mechanism. The values are from the configuration by STEP 7 and are not measured. Here, the configured PN IO update time is the same as the PN IO send clock.

3 Performing the Measurement

3.2 Measurement setup

The figure below shows the principle of the measurement setup. It does not show components (e.g., I/O modules) and signals for the dial indicators (e.g. ready signals) used only to perform the measurement.

The measurement takes place under the following boundary conditions:

- The communication program in the sending station and in the receiving station is called cyclically in OB1 of the S7 controller.
- Exactly one connection is established to each receiving station.
- A complete data block is always sent with a call.
- Source and destination of the data are each located in a data block.

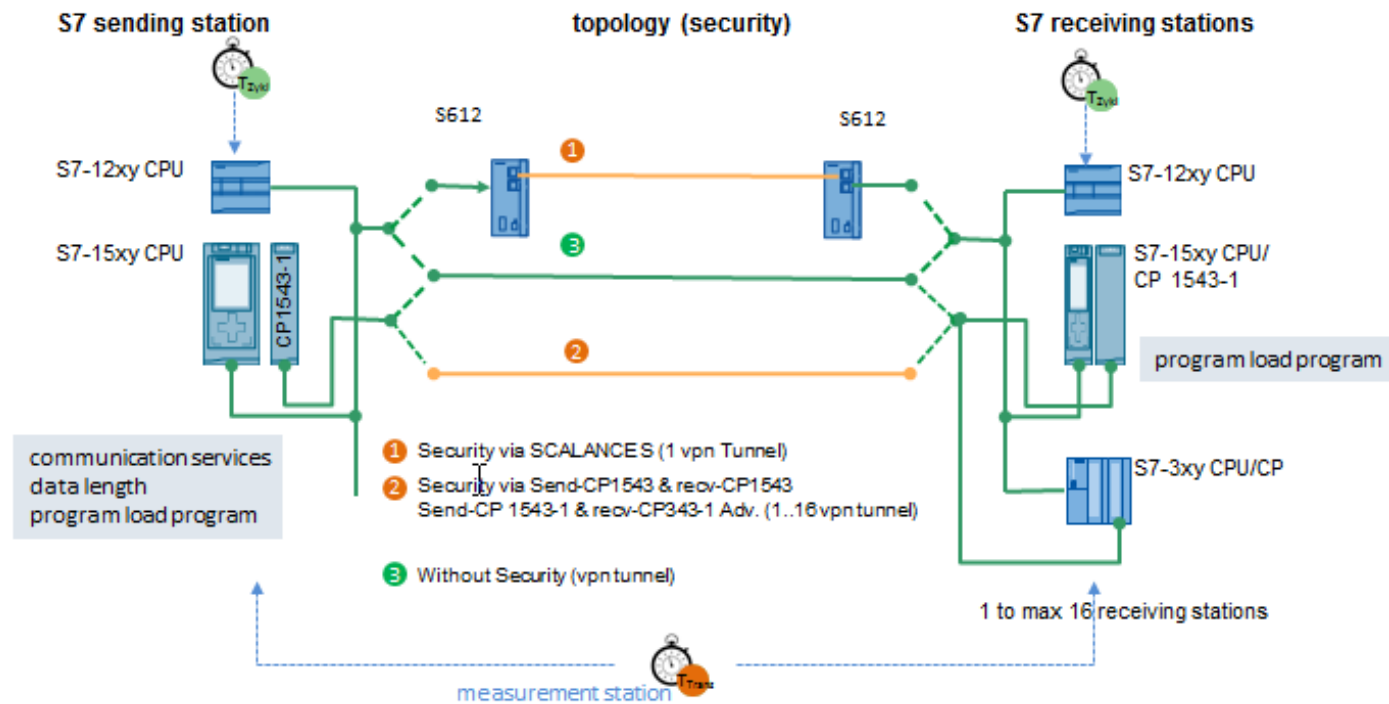

3.3 Measurement: Transfer time

The transfer time indicates how long it takes to send a data packet from the user area (data block) of the sending station to the user area (data block) of all configured receiving stations.

Measurement period

The transfer time is measured in a separate measuring station:

- Start of time measurement:**
 The measuring station triggers the sender for "simultaneous" sending to all receivers; i.e., for all receivers, the send trigger is in the same cycle. Once the send blocks have been executed, a retrigger signal resets the dial indicator to 0. As a result, only the net transmission delay times are measured, regardless of the OB1 cycle.
- Stop of time measurement:**
 The ready signal of all receivers is available in the measuring station.

The ready signal (I/O signal, see figure "Functional model") indicates that the complete transferred data is located in the user area (data block).

Sending and receiving data takes place cyclically in OB1 of the sending and receiving stations. There is exactly one call of the communication functions per cycle.

The measurement is repeated approx. 200-500 times for each configuration (measurement setup). The statistical position parameters are determined from this data.

The following functional model explains the method of measurement:

Figure 3-1

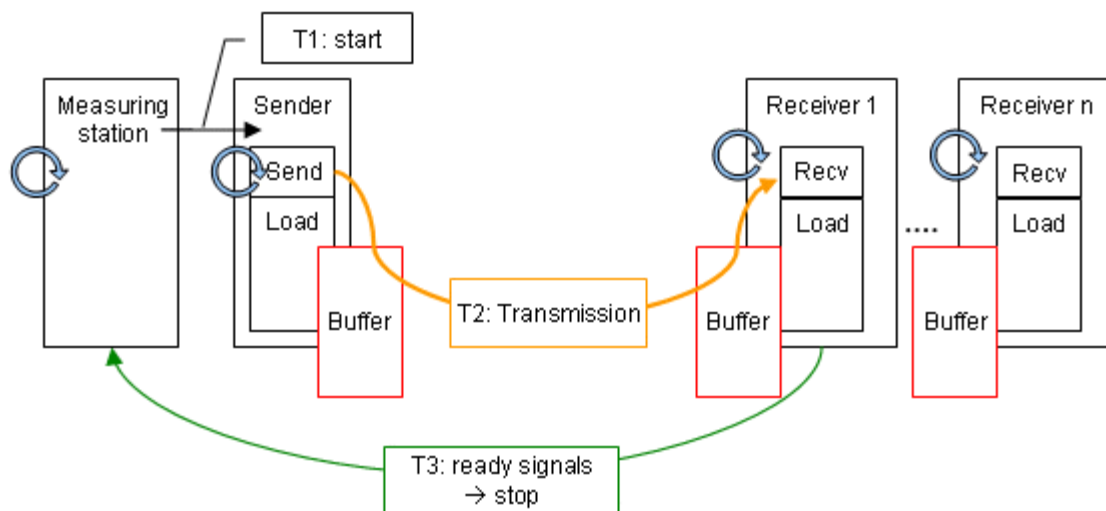

The following table describes the individual time intervals Tx:

Table 3-1

Time	Description	
T1	From	Dial indicator sets start signal via a direct command .
	To	Sender detects start signal via a process alarm .
T2	From	Sender triggers all send jobs. Retriggering of dial indicator.
	To	Data located in user data block of receiving station(s).
T3	From	Receiver sets ready signal via a direct command .
	To	All ready signals were detected by the dial indicator via a process alarm .

Note

The transfer time corresponds to the time T2.

Using a direct command, the process alarm and retriggering in the measuring station minimizes the systematic errors (T1 + T3) caused by the signal propagation time. Otherwise, additional cycle times would be added to the signal propagation times.

Evaluation

From a maximum of 500 single measurements, the dial indicator calculates the statistical position parameters of the measured values. (See Chapter 3.6 Measured variables and statistics.)

3.4 Measurement: Cycle time

Principle

The cycle time in the sending and receiving stations is determined via system functions (S7-1500) and separate measuring programs (S7-1200). From the repeated measurements, the S7 controller automatically determines the statistical position parameters.

Measurement period

- From triggering the data transmission
- To the end of data transmission

Evaluation

From a maximum of 500 single measurements, the dial indicator calculates the statistical position parameters of the measured values. (See Chapter [3.6](#).)

3.5 Measurement: PN IO update time

Principle

As described in Chapter 2.4., cyclic data transmission via the process image is used for the measurement with the "PN IO" communication method.

The "PN IO update time" displayed in the results table is determined by STEP 7 (here: 1 ms and 0.25 ms).

When transmitting data via PN IO, the sending station operates as a PN IO controller via the internal interface. For these configurations, also the receiving stations operate via the internal PROFINET interface.

Measurement period

The transmission time is measured between the following events:

- Start of time measurement**
 The measuring station triggers the sender for setting certain values (samples) in the DB to be transferred. The sender copies the data area from the DB to the configured process output image (POI). This event also starts the dial indicator.
- Stop of time measurement**
 Any receiver that detects these samples in the "receive DB" sets a trigger for the measuring station. As soon as all receivers have signaled the reception of the data, the measuring station stops the time measurement.

Evaluation

From a maximum of 500 single measurements, the dial indicator calculates the statistical position parameters of the measured values. (See Chapter 3.6 Measured variables and statistics.)

3.6 Measured variables and statistics

Location parameters

To be able to make statements about the significance of the mean (median), the other statistical location parameters should also be considered. For this purpose, all measured variables are measured multiple times (up to 500 individual measurements). From all measured values, the measurement system calculates the following statistical values that can then be selected by the user in the results table (by default, however, these position parameters are hidden).

Table 3-2

Location parameter	Definition
TransTime_min	The smallest measured value in the series of measurements that is not an outlier.
TransTime_Q25	The first quartile (Q25) states that 25% of the measured values are below this number.

Location parameter	Definition
TransTime_avg	The median (Q50) indicates the measured value that divides the number of sorted measured values into two halves of equal size. This position parameter is the most important one in the measured value table and always shown by default in the results table.
TransTime_Q75	The third quartile (Q75) states that 75% of the measured values are below this number.
TransTime_max	The largest measured value in the series of measurements that is not an outlier.
Outliers[%]	Percentage of outliers in all measured values.

50% of all measured values are in the so-called interquartile range (IQR), i.e., the range between TransTime_Q25 and TransTime_Q75. This range provides the user with a statement on the spread and reliability of the mean (median).

Definition of outlier

In this measurement, statistical **outliers** are defined as follows:

- If **some** of the measured values are above or below a range $Q75 + 1.5 * IQR$ or $Q25 - 1.5 * IQR$, these values are outliers.
- However, if this range experiences related frequent measured values, these values are nevertheless part of all measured values and not counted as outliers.

In cases of doubt, the distributions were always analyzed individually.

Interpretation

The box plot representation standardized in statistics indicates the spread of the measured values.

Table 3-3

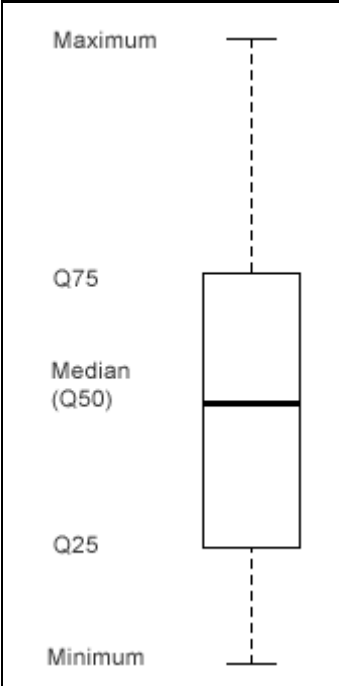
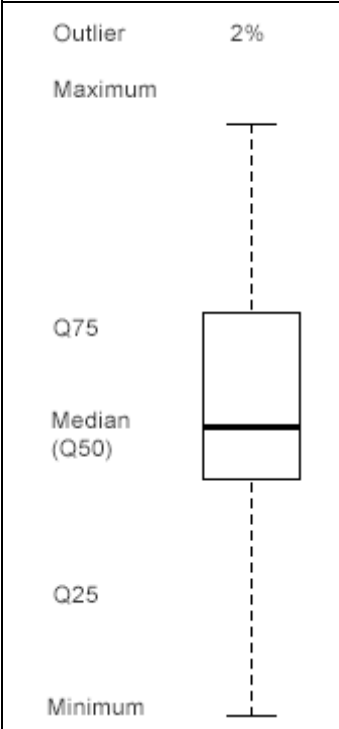
Box plot	Position parameters	Interpretation
	<p>Here the maximum of the measured values is slightly asymmetric to the remaining rest.</p> <p>50% of all measured values are in the IQR range (Q25 to Q75). In this example, this range is relatively large compared to the second example.</p> <p>The median (Q50 value) is fairly symmetrical in the IRQ range.</p>	<p>In this measurement, there is a slight upward deviation.</p> <p>50% of all measured values are spread relatively widely, i.e., the entire IRQ range is more likely for this measurement.</p>
	<p>2% of all measured values are outliers.</p> <p>50% of all measured values are in the IQR range (Q25 to Q75). Compared to the first example, this measurement is much narrower.</p>	<p>The maximum value to be expected without outliers is corrected downwards.</p> <p>The spread of 50% of all measured values is relatively narrow. For this configuration, the results and the value of the median are very meaningful and probable.</p>

3.7 Explanatory notes on the STEP 7 program

The STEP 7 program directly affects the measured values. The following chapters provide you with an overview of the STEP 7 program on which the measured values are based:

3.7.1 Overview of the STEP 7 programs

The table below shows the function of the individual program parts. During a measurement, all program parts are loaded.

Table 3-4

STEP 7 program part		Job in sending station	Job in receiving stations
Measuring program	Communication program	Send data in cyclic OB1	Receive data in cyclic OB1
	Acquisition program	Control measurement and acquire all measured values <ul style="list-style-type: none"> • Acquire measurement start signal • Measure cycle time 	Control measurement and acquire all measured values <ul style="list-style-type: none"> • Generate ready signal • Measure cycle time
Load program		Load S7 controller (in OB1)	Load S7 controller (in OB1)

Composition of the cycle time

The figure below shows the structure of the STEP 7 programs and the definition of the cycle times:

Figure 3-2

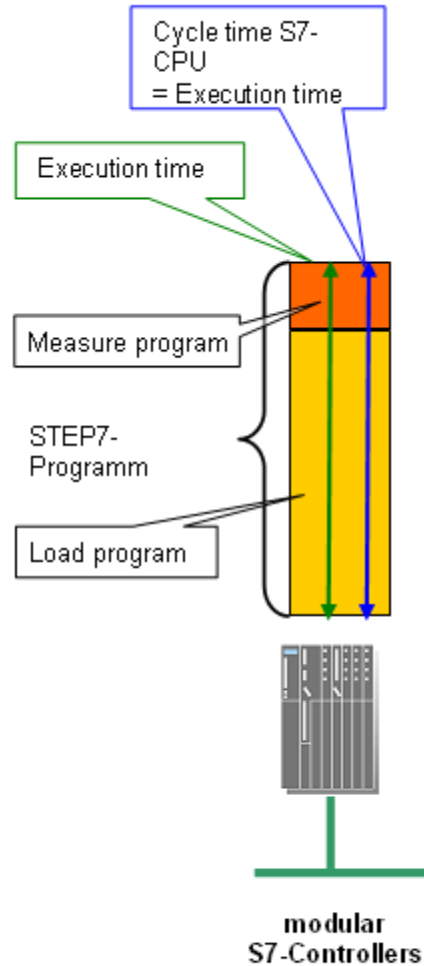

3.7.2 Communication program

The table below describes the properties of the communication program:

Table 3-5

Location	Properties
Sending station	<ul style="list-style-type: none"> • Exactly one connection is configured to each receiving station (exception: communication via PN IO process image) • The communication program is called in the cyclic OB1. • The complete configured data block is always sent with each call of the send blocks. • An optimized data block (if possible) is always used as the data source.
Receiving station	<ul style="list-style-type: none"> • The communication program is called in the cyclic OB1. • The station always receives a complete data block. • The received data block is always stored in an optimized data block (if the hardware allows this).

3.7.3 Load program

The load program is part of the STEP 7 program in the S7 controller. The size (length) of the load program is selected such that a "cycle time without communication" results in the S7 controller.

Definition of "cycle time without communication"

The "cycle time without communication" is the cycle time set in the S7 controller when the S7 controller is **not** subject to influences of the communication. For the S7 controller, this means that no data is sent and that the communication blocks are not processed.

Defining a "cycle time without communication"

To be able to define the "cycle time without communication", a load program is downloaded to the S7 controller. This load program allows the user to simulate the case occurring in practice that other control tasks are performed in the S7 controller simultaneously with the communication. The load program is implemented with a simple loop that does not influence the remaining program. The variation of the executed loops can therefore be used to set the "cycle time without communication".

Selecting the "cycle time without communication"

For this measurement, the length of the load program was always selected such that there is a no-load cycle time ("cycle time without communication") of **6ms** (low CPU load due to control tasks) or **100ms** (high CPU load due to control tasks). This implies that the length of the load program varies per S7 controller to ensure that the desired no-load cycle time is set.

4 Version

Table 4-1

Measurement version	Measurement setup	Publication	Description
V 5.0	2014	January 2015	Repeated measurement
V 4.0	Mid-2009	February 2010	Repeated measurement + new web appearance
V 3.5	Mid-2008	January 2009	Repeated measurement
V 3.0	Mid-2007	October 2007	Repeated measurement
V 2.0	Late 2006	February 2007	Repeated measurement
V 1.0	Mid-2005	October 2005	First measurement